

部品番号	部品記号	コメント
O1	2SK160K5	RF AMP
O2	2SB624BV2	POWER
O3	2SC1623L5A	SWITCHING
D1	MA721	DATE
IC1	AN7002S	AM MIX IF AFAMP
L1	RLF2N2S-0	AM ANT
L2	RL02U3-M	AM OSC COIL
CF1	RVFPFB45SR	
VR1	RVV1H5R14-A	

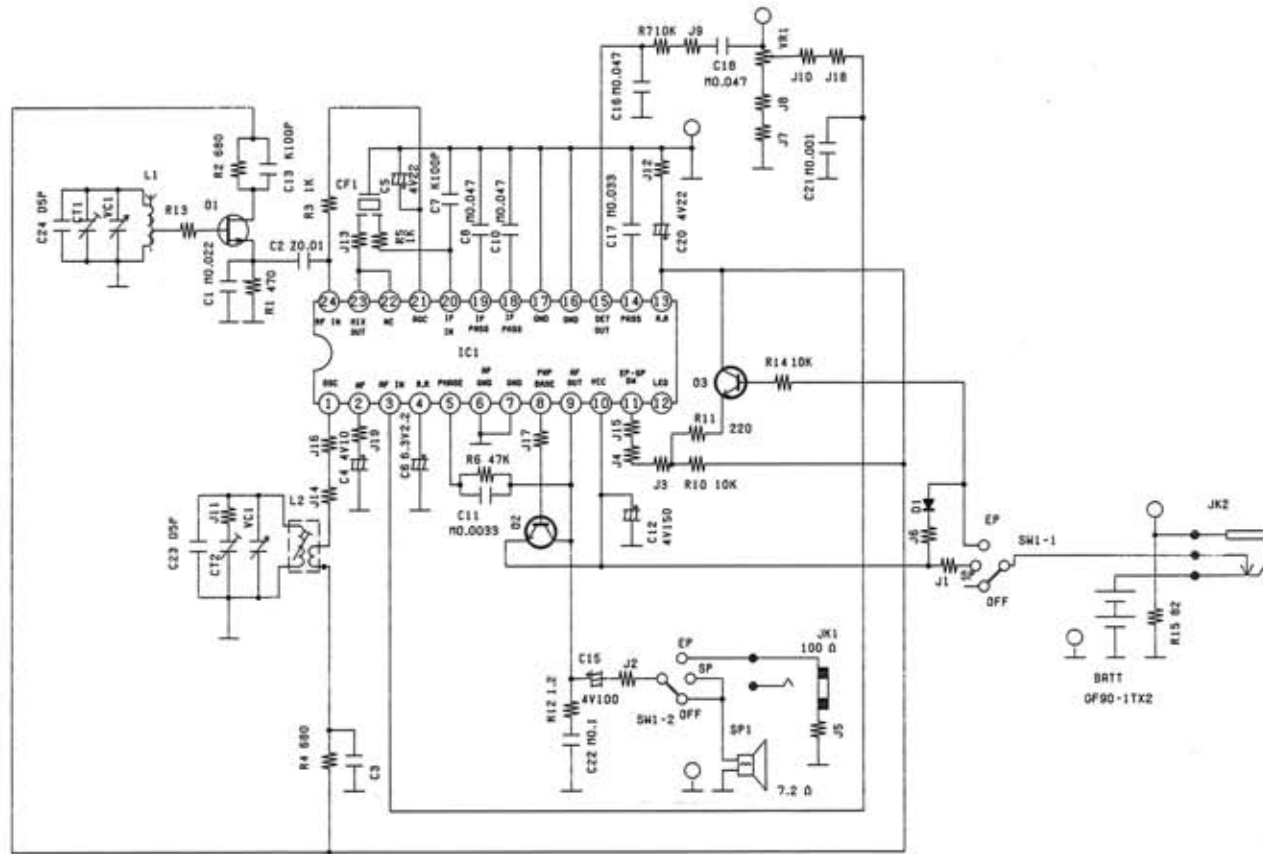

NOTES

CAPACITOR
 TOLERANCE NO MARK IS Z
 UNIT NO MARK IS μ F , P IS PF

RESISTORS
 TOLERANCE NO MARK IS K (\pm 10%)
 UNIT NO MARK IS Ω , K IS K Ω
 M IS M Ω

	MISS NO.	LAST NO.
C	24 23 1 2 13 4 3 5 6 7 11 8 10 22 17 15 16 12 20 18 21	9 14 19 24
R	13 2 1 4 3 5 6 12 10 7 11 14 15	8 9 15

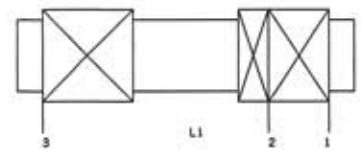
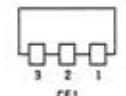
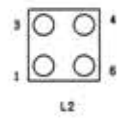
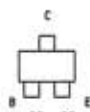
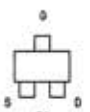
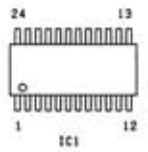

Designed	Checked	Approved	Model
			R-H11-J